



Scheda Tecnica - Technical Sheet

Adattatore semplice

Simple adapter plug



Art.
300610B
300610N

Adattatore Schuko semplice

2P+T 10A~ 250V
Schuko 2P+T
10/16A~ 250V



Dimensioni: **43x43xh70 mm**
Size:

Spina 2P+T 10A~ 250V
Presca Schuko 2P+T
10/16A~ 250V
Plug 2P+T 10A~ 250V
Socket Schuko 2P+T 10/16 A~ 250V

Colori: Bianco - Nero
Colours: White - Black

Corpo in polimero
Potenza max 1500W
Spinotti in ottone nichelato
Prese grado prot. 2.1
Polymer body
Max power 1500W
Nickel-plated brass pins
Sockets with protection 2.1



Certificazione IMQ

NORME: CEI 23-50
CEI 23-57



Packaging

Art. 300610

Scatolo con stampa in quadricromia
Giftbox 4 colours

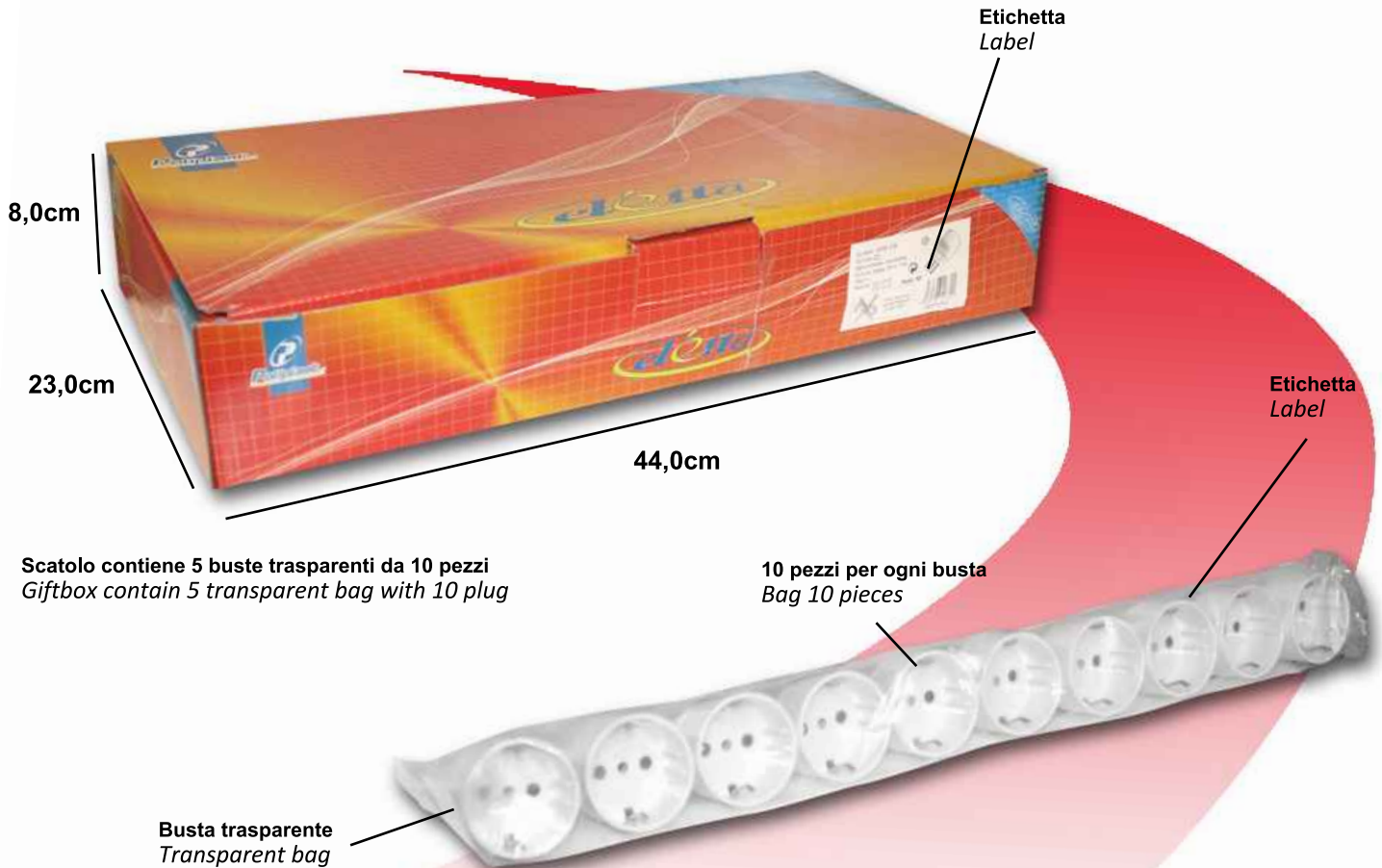

Export Carton/PCS

Bar Code:
Position 4 sides
in the upper left



Lateral Sides
Shipping Mark:

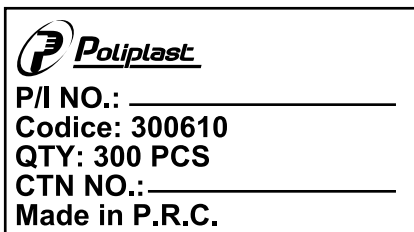

Central Sides
Shipping Mark:

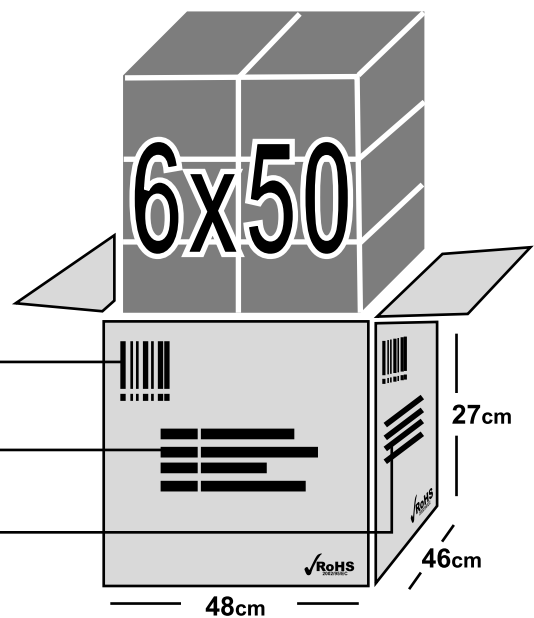
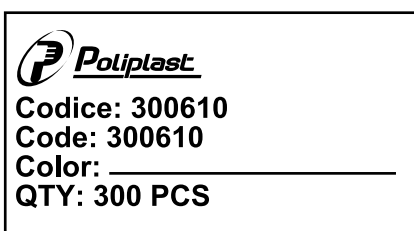

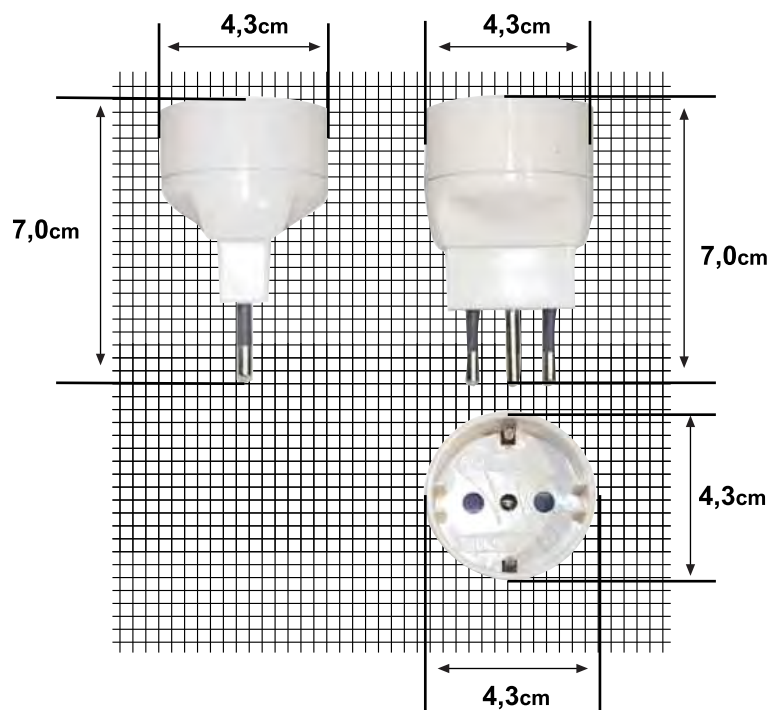
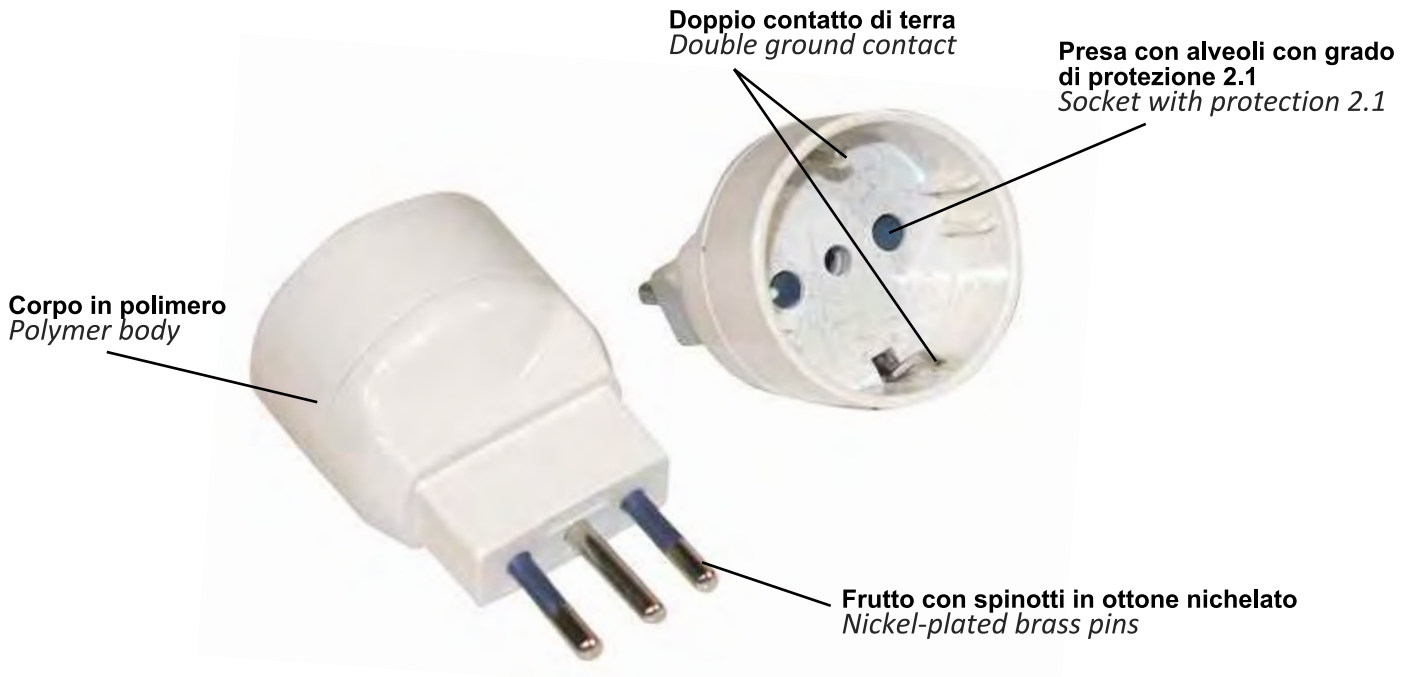

Art. 300610N
70x50 mm
Etichetta per lo scatolo
Label for box

Codice: 300610N
 Colore: ■
 Descrizione: Adattatore Schuko
 Spina 2P+T 10A 250V~
 Norme: CEI 23-50
 CEI 23-57 **Pezzi: 50**



Non inserire
un adattatore
in un altro



8 032706 127387
Made in P.C.R.

Art. 300610B
70x50 mm
Etichetta per lo scatolo
Label for box

Codice: 300610B
 Colore: □
 Descrizione: Adattatore Schuko
 Spina 2P+T 10A 250V~
 Norme: CEI 23-50
 CEI 23-57 **Pezzi: 50**





Non inserire
un adattatore
in un altro



8 032706 127301
Made in P.C.R.

elètta Poliplast

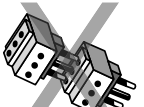
Codice: 300610N
 Colore: Nero
 Descrizione: Adattatore Schuko
 Spina 2P+T 10A 250V~
 Norme: CEI 23-50
 CEI 23-57

Non inserire
un adattatore
in un altro

Pezzi: 10
Made in P.C.R.



8 032706 127387

85x40 mm
Etichetta per la busta
Label for bag

elètta Poliplast

Codice: 300610B
 Colore: Bianco
 Descrizione: Adattatore Schuko
 Spina 2P+T 10A 250V~
 Norme: CEI 23-50
 CEI 23-57

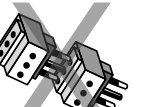
Non inserire
un adattatore
in un altro

Pezzi: 10
Made in P.C.R.



8 032706 127301

85x40 mm
Etichetta per la busta
Label for bag



IMQ S.p.A. Società a Socio Unico
I-20138 Milano - via Quintiliano, 43
tel. 0250731 (r.a.) - fax 0250991500
e-mail: info@imq.it - www.imq.it

Rea Milano 1595884
Registro Imprese MI 12898410159
C.F./P.I. 12898410159
Capitale Sociale € 4.000.000

CA02.04173
SN.K0004I

PID:
02114000
CID:
CN.F00089

Certificato di approvazione
Approval certificate

IMQ, ente di certificazione accreditato, *IMQ, accredited certification body, grants to*
autorizza la ditta

POLIPLAST SRL
ZONA INDUSTRIALE 13esima STRADA N. 34-36
95121 CATANIA CT

all'uso del marchio

the licence to use the mark

IMQ

Il presente certificato è
soggetto alle condizioni
previste nel Regolamento
"MARCHI IMQ -
Regolamento per la
certificazione di prodotti" ed
è relativo ai prodotti
descritti nell'Allegato al
presente certificato.



per i seguenti prodotti

for the following products

Adattatori per uso domestico
(Rif. di tipo 300610)

Adaptors for domestic purposes
(Type ref. 300610)

*This certificate is subjected to
the conditions foreseen by Rules
"IMQ MARKS - RULES for
product certification" and is
relevant to the products listed in
the annex to this certificate.*

Emesso il / Issued on **2010-02-04**
Aggiornato il / Updated on **2014-10-20**
Sostituisce / Replaces **2010-02-04**

